



## GER-10ST Automotive Relay

### Summary

1. 500V Pre-charge Relay for e-Mobility
2. Max. Continuous Current: 10A
3. Electrical Life: 150,000ops. at 10A, 450VDC

### • Contact Data

<b>Contact Arrangement</b>	SPST-NO
<b>Max. Operating Voltage</b>	500VDC
<b>Max. Continuous Current</b>	10A
<b>Min. Switching Load</b>	1A 12VDC
<b>Contact Voltage Drop(Initial)</b>	Max. 0.5V at 10A
<b>Electrical Life</b>	150,000ops. (at 10A, 450VDC, 360Cycles/h)
<b>Mechanical Life</b>	Min. 150,000ops.
<b>Short Time Current</b>	10A (cont., 2mm <sup>2</sup> ) 15A (2min., 2mm <sup>2</sup> ) 30A (30s., 2mm <sup>2</sup> )

### • Characteristics

<b>Initial Breakdown Voltage</b> Between Open Contacts Between Contacts and Coil	2,200Vrms/min. (Detection Current: 10mA)
<b>Initial Insulation Resistance</b>	Min. 100MΩ (at 500VDC)
<b>Operate Time (at 20°C)</b>	Max. 50ms
<b>Release Time (at 20°C)</b>	Max. 30ms
<b>Shock Resistance</b> Functional Destructive	196m/s <sup>2</sup> (20G) <sup>(1)</sup> 490m/s <sup>2</sup> (50G) <sup>(2)</sup>
<b>Vibration Resistance</b> Functional Destructive	1.0G <sup>(3)</sup> 4.5G <sup>(4)</sup>
<b>Humidity</b>	5 ~ 95%R.H.
<b>Ambient Temperature</b>	-40 ~ 85°C
<b>Tightening Torque</b> Mounting Hole Main Terminal	(M4): 1.8 to 2.7N·m N / A
<b>Degree of Protection</b>	IP40
<b>Approx. Weight</b>	80g

<sup>(1)</sup> Relay On: 11ms half sine

<sup>(2)</sup> Relay On: 9ms half sine wave

<sup>(3)</sup> 10 to 1,000Hz Time of vibration for each X,Y,Z direction: 8 hours

<sup>(4)</sup> 10 to 200Hz in increments of 10 Time of vibration for each X, Y, Z direction: 4 hours

### • Coil Data

\*At room temperature

Single Coil					
Rated Voltage	Pick-up Voltage	Drop-out Voltage	Max. Allowable Voltage	Max. Power Consumption	Coil Resistance
12VDC	Max. 9VDC	Min. 1.2VDC	16VDC	3.0W at 12VDC	46.5Ω ±10%



• Dimension

GER-10ST

Unit: mm

**General Tolerance**

**Less Than 10:** ±0.3/ 10-50: ±0.5  
**More Than 50:** ±0.8

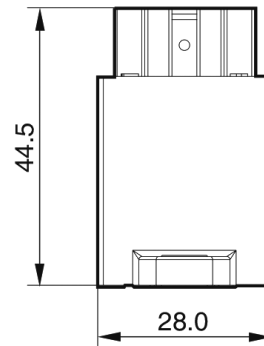
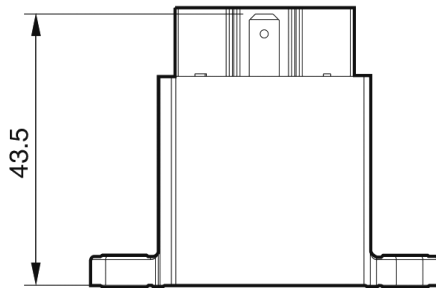
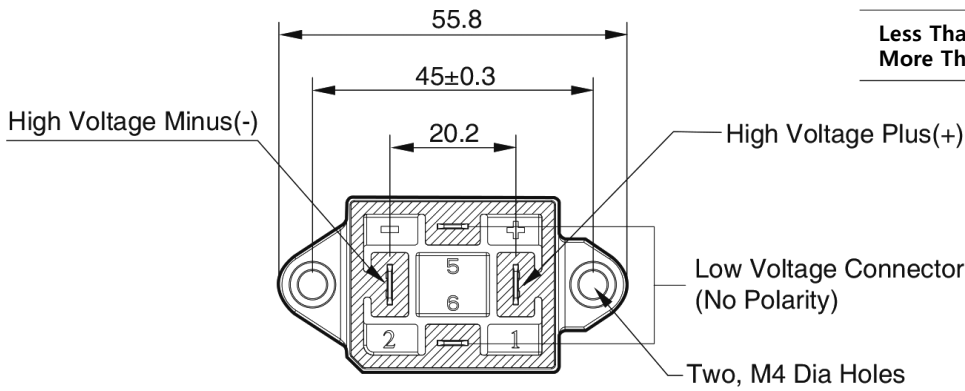

**Coil Terminal Accessory**

Main Terminal	Coil Terminal	Accessory(Not Included)
<p><b>Pin Type Features</b></p> <ul style="list-style-type: none"> <li>• Terminal Type = Tab</li> <li>• Mating Area Interface</li> <li>• Dimensions(mm) 6.3×0.80</li> <li>• Material = Brass</li> </ul>	<p><b>Pin Type Features</b></p> <ul style="list-style-type: none"> <li>• Terminal Type = Tab</li> <li>• Mating Area Interface</li> <li>• Dimensions(mm) 4.8×0.80</li> <li>• Material = Brass</li> </ul>	<p><b>Components</b></p> <ul style="list-style-type: none"> <li>• Main Terminal accessory: 2EA</li> <li>• Coil Terminal accessory: 2EA</li> <li>• Wire length: 300mm</li> </ul>



• Engineering Data

Operating Voltage Data

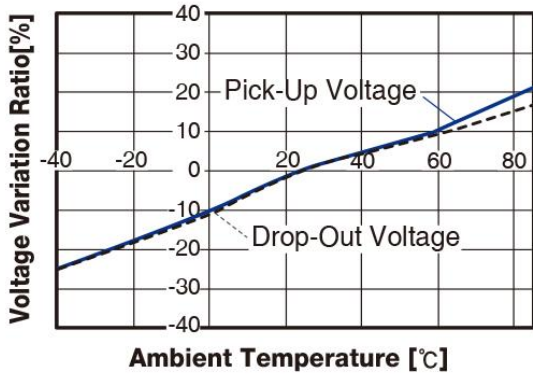

Current Distribution(2mm<sup>2</sup> at 85°C)

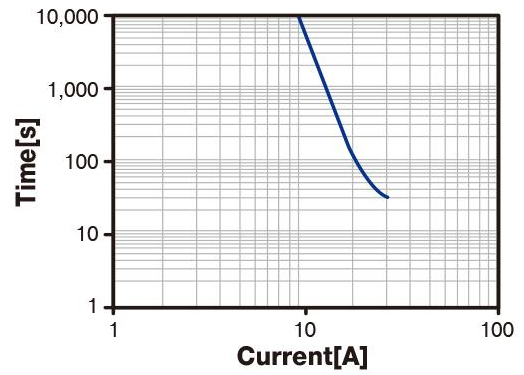

Switching / Cut-off Curve

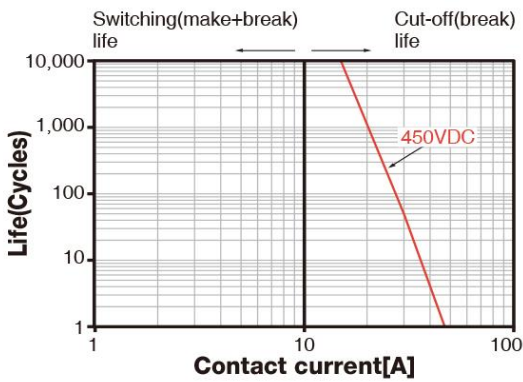



Ordering Information (Reference)

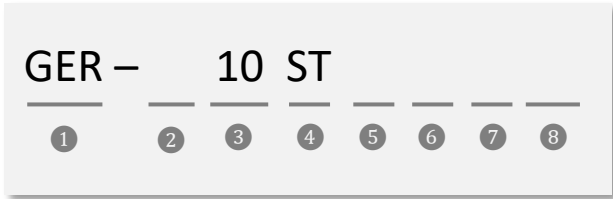

- 1 GER: Green Electrical vehicle Relay  
GPR: Green Power Relay
- 2 Operating Voltage
  - Blank ≤450V
  - M 450-1000V
  - H 1000-1500V
- 3 Conventional thermal Current
 

010	10A	200	200A
040	40A	250	250A
100	100A	400	400A
150	150A	500	500A
- 4 Product Type
  - ST: Standard parts
  - Customized product
    - VV VOLVO
    - VW Volkswagen
    - BW BMW
- 5 Auxiliary Contact
  - Blank: N/A
  - A: N-O
  - B: N-C
- 6 Control Voltage
  - Blank: DC12V
  - DC24V: DC24V
- 7 Mounting Type
  - Blank: Bottom Mounting
  - SM: Side Mounting
  - PI: Plug In Type
- 8 Main Feature
  - G2: New Generation 2
  - SL: SLIM
  - 2CO: 2Coil Control
  - 1CO: 1Coil Control
  - PWM: PWM Control
  - CV: Connector Vertical
  - 48V: Rated Voltage 48V
  - ET: Economic Type
  - CYET: Cylindrical Effective Type



- Instructions for use

#### Main Contactor

1. Length of bolts to main contacts of relay should be 6~8mm except bus bar/terminal.
2. Contacts of relay can be oxidized in the air causing some discoloration, but there is no problem to use.
3. Excessive load input to main contacts and over-life may cause heat generation.
4. Avoid oil or foreign substances adhering to main contacts, there may be heat generation to the contacts.
5. Contact resistance may increase due to torque applied to the main contacts or vibration / shock during movement. In this case, please re-measure by applying voltage / current of actual use condition.

#### Mounting

1. Use the torque range specified in catalog, when tightening screws and nuts to fixed mounting or main contacts.
2. We generally recommend tightening the relays using bolts. When using nuts, the fixed mounting injection part may be pushed and broken. (Use a flat nut when using nuts.)
3. When designing the fixed mounting mounted to relay, please make sure that injection area is not pressed. Fixed mounting of the relay can be broken.
4. Relays can be assembled in forward and 90-degree rotation but cannot be assembled in 180-degree rotation.

#### Coil

1. Do not turn off the coil while power is supplied to the main contacts of relay. The relay may be damaged.
2. Excessive load input to coil part may cause heat generation.
3. If voltage is applied slowly to the coil, the relay may not operate. Please operate the coil promptly.
4. When load is applied to main contacts and relay coil turns on/off, coil temperature rises so that coil resistance can rise. In this case, operating voltage may exceed the rated voltage. To avoid this situation, we recommend that you take precautions such as increasing the load current, limiting voltage application time, and applying high coil voltage and nominal voltage.
5. When measuring the withstanding voltage(Initial Breakdown Voltage), measure the relay in OFF state.

#### Installation

1. Please avoid cross-connection as it may cause malfunction or overheating.
2. If distance between relays is close or if heat generating parts are located close to relay, be careful of temperature rise and insulation (minimum distance between relays is at least 10mm).
3. Use a conductor suitable for the specific current. Failure to meet recommended size(SQ) of conductor may cause heat problems. (It is necessary to consider the condition when installing the module)
4. When wiring, make sure that the power supply is disconnected. Relays can be damaged.



## • Instructions for use

### Environment

1. Use pick-up/drop-out voltage according to the operating environment. Pick-up/drop-out voltage may vary.
2. Relay life may vary depending on load type used, operating frequency, coil drive circuit and surrounding environment.
3. When using a capacitor, make sure that inrush current should not exceed the rated current of relay(95% or more capacitor charging is recommended)
4. When using inductive load L / R 1ms, measures such as installing surge absorbers in parallel should be taken in order to prevent shortening of electrical life or contact failure.
5. Do not install relays near objects that emit strong magnetic fields or heat.
6. If relays are installed close to each other or near magnetic parts such as motors and speakers, the relays may change operating characteristics or cause malfunctions. Therefore, check the performance under actual operating conditions, after installation.
7. If a product such as current sensor is installed near relay, check the performance under actual operating conditions. There may be a problem to output.
8. When pulling lead wire of the female connector on the opposite side, do not pull it with a force of more than 0.5N. There may be a problem with the product.
9. This product is not waterproof. (IP40)
10. Do not use the product in an environment where organic solvents such as alcohol, benzene, thinner, and strong alkali (ammonia or caustic soda) can easily adhere to the product.
11. Additional components should not be applied to the relay housing.
12. Please note that welding may occur in following environments : inrush current, shutdown, short circuit, low coil voltage, fuse combination
13. Make sure that resonance does not occur at relay mounting area. Vibration values guaranteed may be exceeded due to the resonance.
14. Do not use products that have fallen during use or transportation. It may cause malfunction.
15. If temperature changes suddenly, there may be a problem with current-carrying of the relay.

• **Headquarter : 95, Baekbong-ro, Heungdeok-gu, Cheongju-si, Chungcheongbuk-do, Republic of Korea (28439)**

#### • Sales Team

- US sales [htha@lsems.com](mailto:htha@lsems.com)
- European sales [shyoon2@lsems.com](mailto:shyoon2@lsems.com)
- Asian sales [smlee@lsems.com](mailto:smlee@lsems.com)
- China sales [kjyima@lsems.com](mailto:kjyima@lsems.com)

#### • Technical Support

- US [yjson@lsems.com](mailto:yjson@lsems.com)
- KO / CN [hmrkim@lsems.com](mailto:hmrkim@lsems.com)